

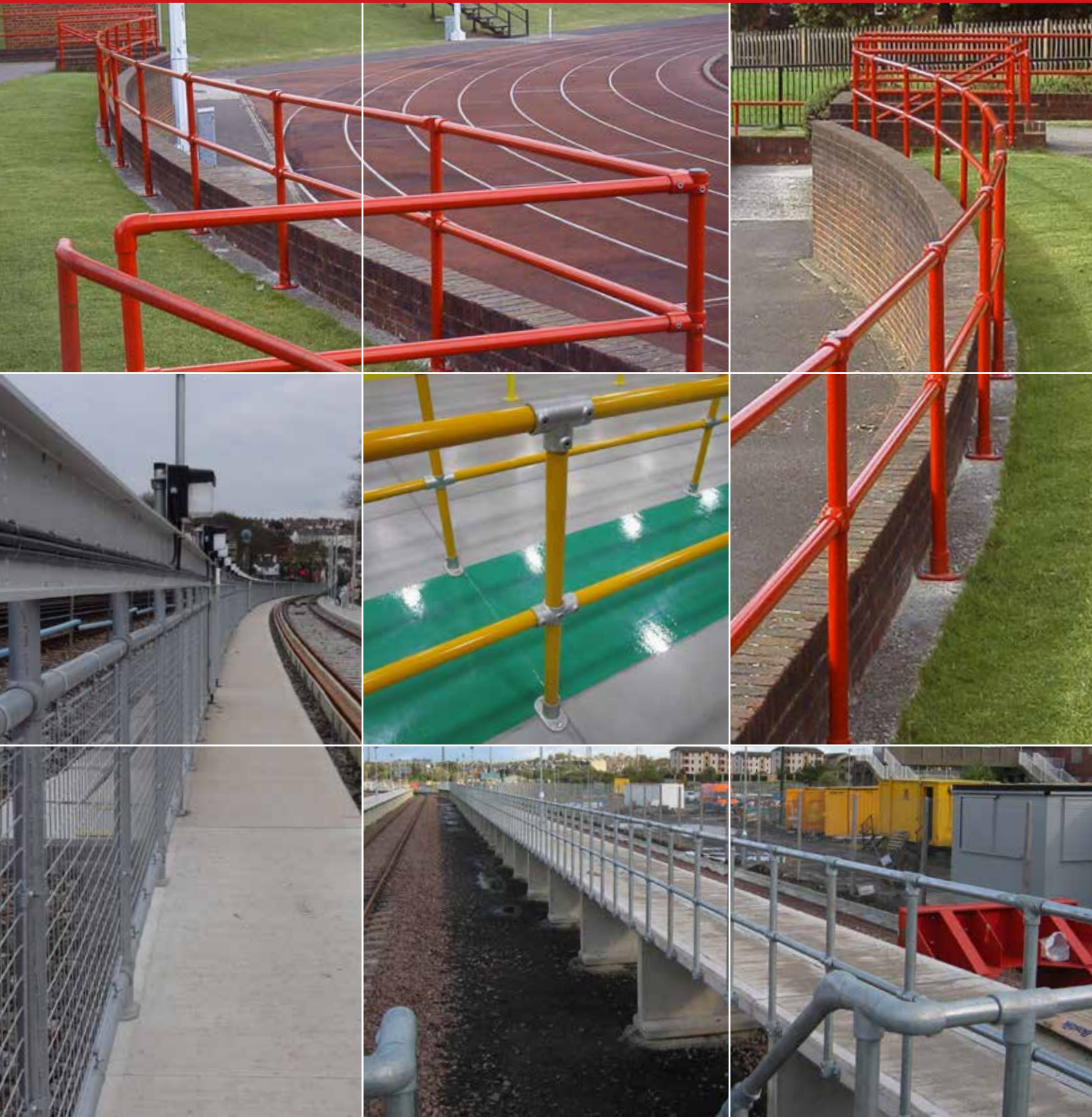









YOU'LL NEVER BE BETTER PROTECTED

Safety Components Guide



● Kee Lite aluminium version available

<p>Single Socket Tee</p> <p>10</p>  <p>Type 10-3 10-75 10-4 10-76 10-5 10-78 10-6 10-8 10-65 10-87 10-67 10-9 10-7 10-98</p>	<p>Split Single Socket Tee</p> <p>A10</p>  <p>Type A10-7 A10-8</p>	<p>Single Socket Tee</p> <p>12 45°</p>  <p>Type 12-5 12-6 12-7 12-8</p>	<p>Split Single Socket Tee</p> <p>A12 45°</p>  <p>Type A12-8</p>	<p>Straight Coupling</p> <p>14</p>  <p>Type 14-4 14-5 14-6 14-7 14-8 14-9</p>
<p>Elbow</p> <p>15 90°</p>  <p>Type 15-4 15-5 15-6 15-7 15-8 15-9</p>	<p>Clamp-on Tee</p> <p>16</p>  <p>Type 16-5 16-6 16-7 16-8 16-9</p>	<p>Clamp-on Crossover</p> <p>17</p>  <p>Type 17-5 17-6 17-7 17-78 17-8 17-9</p>	<p>Internal Coupling</p> <p>18</p>  <p>Type 18-6 18-7 18-8</p>	<p>Adjustable Side Outlet Tee</p> <p>19*</p>  <p>Type 19-5 19-6 19-7 19-8 19-85 19-9</p>
<p>Side Outlet Elbow</p> <p>20</p>  <p>Type 20-4 20-5 20-6 20-7 20-8 20-9</p>	<p>Side Outlet Tee</p> <p>21 90°</p>  <p>Type 21-4 21-5 21-6 21-7 21-8 21-9</p>	<p>Split Two Socket Side Outlet Tee</p> <p>A21 90°</p>  <p>Type A21-8</p>	<p>Three Socket Tee</p> <p>25</p>  <p>Type 25-4 25-5 25-6 25-7 25-8 25-9</p>	<p>Two Socket Cross</p> <p>26</p>  <p>Type 26-3 26-7 26-4 26-8 26-5 26-87 26-6 26-9</p>
<p>Split Two Socket Cross</p> <p>A26</p>  <p>Type A26-8</p>	<p>Single Socket Tee</p> <p>29 30°-60°</p>  <p>Type 29-6 29-7 29-8</p>	<p>Adjustable Cross</p> <p>30 30°-45°</p>  <p>Type 30-6 30-7 30-8</p>	<p>Pallet Flange</p> <p>31</p>  <p>Type 31-8</p>	<p>Decorative Ball</p> <p>32</p>  <p>Type 32-7 32-8</p>
<p>Three Socket Cross</p> <p>35</p>  <p>Type 35-4 35-5 35-6 35-7 35-8 35-9</p>	<p>Split Three Socket Cross</p> <p>A35</p>  <p>Type A35-8</p>	<p>Four Socket Cross</p> <p>40</p>  <p>Type 40-4 40-5 40-6 40-7 40-8 40-9</p>	<p>Split Four Socket Cross</p> <p>A40</p>  <p>Type A40-8</p>	<p>Crossover</p> <p>45</p>  <p>Type 45-3 45-76 45-4 45-8 45-5 45-86 45-6 45-87 45-65 45-9 45-7 45-98</p>
<p>Split Crossover</p> <p>A45</p>  <p>Type A45-7 A45-8</p>	<p>Combination Socket Tee and Crossover</p> <p>46</p>  <p>Type 46-4 46-5 46-6 46-7 46-8 46-9</p>	<p>Single Swivel Socket</p> <p>C50</p>  <p>Type C50-44 C50-55 C50-66 C50-77 C50-88 C50-99</p>	<p>Female Single Swivel Socket Member</p> <p>F50</p>  <p>Type F50-4 F50-5 F50-6 F50-7 F50-8 F50-9</p>	<p>Male Single Swivel Socket Member</p> <p>M50</p>  <p>Type M50-4 M50-5 M50-6 M50-7 M50-8 M50-9</p>
<p>Male Single Horizontal Swivel Socket Member</p> <p>MH50</p>  <p>Type MH50-6</p>	<p>Modified M50-8 with Offset Slot</p> <p>P50</p>  <p>Type P50-8</p>	<p>Double Swivel Socket</p> <p>C51</p>  <p>Type C51-555 C51-666 C51-777 C51-888 C51-999</p>	<p>Male Double Swivel Socket Member</p> <p>M51</p>  <p>Type M51-5 M51-6 M51-7 M51-8 M51-9</p>	<p>Male Double Horizontal Swivel Socket Member</p> <p>MH51</p>  <p>Type MH51-6</p>
<p>Modified M51-8 with Offset Slots</p> <p>P51</p>  <p>Type P51-8</p>	<p>Corner Swivel Socket</p> <p>C52</p>  <p>Type C52-555 C52-666 C52-777 C52-888</p>	<p>Male Corner Swivel Socket Member</p> <p>M52</p>  <p>Type M52-5 M52-6 M52-7 M52-8</p>	<p>Swivel Elbow</p> <p>BC53</p>  <p>Type BC53-66 BC53-77 BC53-88</p>	<p>Adjustable Three Way Swivel Socket</p> <p>C53</p>  <p>Type C53-888</p>
<p>Variable Angle Double Swivel Socket Member</p> <p>M53</p>  <p>Type M53-8</p>	<p>Obtuse Angle Elbow</p> <p>55</p>  <p>Type 55-6 55-7 55-8</p>	<p>Variable Elbow</p> <p>55A 11°-30°</p>  <p>Type 55A-7 55A-8</p>	<p>Acute Angle Elbow</p> <p>56 30°-45°</p>  <p>Type 56-7 56-8</p>	<p>Acute Angle Elbow</p> <p>56A 11°-30°</p>  <p>Type 56A-7 56A-8</p>

<p>Modified M50-8 with Slot</p> <p>P57</p>  <p>Type P57-8</p>	<p>Modified P57</p> <p>P57E</p>  <p>Type P57E-7</p>	<p>Swivel Flange</p> <p>C58</p>  <p>Type C58-5 C58-6 C58-7 C58-8 C58-9</p>	<p>Swivel Flange Plate</p> <p>M58</p> 	<p>Double Central Flange Fitting</p> <p>P58</p>  <p>Type P58-7</p>
<p>Spigot Flange</p> <p>59</p>  <p>Type 59-5 59-6 59-7 59-8 59-9</p>	<p>Extra Heavy Flange</p> <p>60</p>  <p>Type 60-5 60-6 60-7 60-8</p>	<p>Flange</p> <p>61</p>  <p>Type 61-3 61-4 61-5 61-6 61-7 61-8 61-9</p>	<p>Standard Railing Flange</p> <p>62</p>  <p>Type 10-5 10-6 10-7 10-8 10-9</p>	<p>Angle Base Flange</p> <p>63 45°-60°</p>  <p>Type 63-6 63-7 63-8</p>
<p>Standard Vertical Railing Base</p> <p>64</p>  <p>Type 64-6 64-7 64-8</p>	<p>Standard Horizontal Railing Base</p> <p>65</p>  <p>Type 65-6</p>	<p>Ground Socket</p> <p>66</p>  <p>Type 66-6 66-7 66-8</p>	<p>Angle Flange</p> <p>67 3°-11°</p>  <p>Type 67-7 67-8</p>	<p>Wall Flange</p> <p>68</p>  <p>Type 68-6 68-7 68-8</p>
<p>Railing Flange with Toeboard Adapter</p> <p>69</p>  <p>Type 69-6 69-7 69-8</p>	<p>Rail Support</p> <p>70</p>  <p>Type 70-5 70-6 70-7 70-8</p>	<p>Weather Cap</p> <p>71</p>  <p>Type 71-6 71-7 71-8</p>	<p>Stair Tread Support</p> <p>72</p>  <p>Type 72-8</p>	<p>Collar</p> <p>75</p>  <p>Type 75-4 75-5 75-6 75-7 75-8</p>
<p>Hook</p> <p>76</p>  <p>Type 76-5 76-6 76-7 76-8</p>	<p>Plastic Plug</p> <p>77</p>  <p>Type 77-4 77-5 77-6 77-7 77-8 77-9</p>	<p>Eye Fitting</p> <p>78</p>  <p>Type 78-5 78-6 78-7 78-8</p>	<p>Sheeting Clip</p> <p>79</p>  <p>Type 79-7</p>	<p>Single Sided Clip</p> <p>81</p>  <p>Type 81-5 81-6 81-7 81-8 81-9</p>
<p>Double Sided Clip</p> <p>82</p>  <p>Type 82-5 82-6 82-7 82-8 82-9</p>	<p>Pin Fitting</p> <p>83</p>  <p>Type 83-5 83-6 83-7 83-8</p>	<p>Malleable Plug</p> <p>84</p>  <p>Type 84-5 84-6 84-7 84-8 84-9</p>	<p>Angle Tee</p> <p>86 0°-11°</p>  <p>Type 86-7 86-8</p>	<p>Angle Elbow</p> <p>87 0°-11°</p>  <p>Type 87-7 87-8</p>
<p>Three Socket Angle Tee</p> <p>88 0°-11°</p>  <p>Type 88-7 88-8</p>	<p>Two Socket Angle Cross</p> <p>89 0°-11°</p>  <p>Type 89-7 89-8 89-8</p>	<p>PGR Three Socket Tee</p> <p>90</p>  <p>Type 90-8</p>	<p>PGR Two Socket Tee</p> <p>91</p>  <p>Type 91-8</p>	<p>PGR Elbow</p> <p>92</p>  <p>Type 92-8</p>
<p>PGR Tee</p> <p>93</p>  <p>Type 93-8</p>	<p>Set Screws</p> <p>97</p>  <p>Type 97-3 97-4 97-56 97-56S* 97-789 97-789S*</p>	<p>Anti-Theft Device</p> <p>97ATD</p> 	<p>Hex Key</p> <p>99</p>  <p>Type 98-3 98-4 98-56 98-789</p>	<p>Plastic Set Screw Cap</p> <p>100</p>  <p>Type 100-56 100-789</p>
<p>Sheeting Clip without Hardware</p> <p>105</p>  <p>Type 105-6 105-7 105-8 105-9</p>	<p>Swivel Tee</p> <p>114</p>  <p>Type 114-6 114-7 114-8</p>	<p>Horizontal Railing Base</p> <p>115</p>  <p>Type 115-6 115-7 115-8</p>	<p>Packer Plate for Type 115</p> <p>S115</p> 	<p>Cover Flange</p> <p>118</p>  <p>Type 118-8</p>

*Stainless steel

● Kee Lite aluminium version available

Corner Crossover 121  Type 121-7	Crossover Coupling 145  Type 145-7	Toeboard TB150  Type TB150 Aluminium Toeboard TB2 Straight Connector TB2C Right Angle Connector TPFP1 Fixing Pack TB3-7 Saddle Bracket TB3-8 Saddle Bracket	Single Sided Fixing Bracket 199  Type 199-6 199-7 199-8	Double Sided Fixing Bracket 200  Type 200-6 200-7 200-8
Round Base Flange 262  Type 262-8	Offset Rail Wall Flange 265  Type 265-7 265-8	Parapet Flange 316  Type 316-7 316-8	Left Hand Level to Sloping Down Side Outlet Elbow 320LH 30°-45°  Type 320LH-7 320LH-8	Right Hand Level to Sloping Down Side Outlet Elbow 320RH 30°-45°  Type 320RH-7 320RH-8
Left Hand Level to Sloping Down Side Outlet Tee 321LH 30°-45°  Type 321LH-7 321LH-8	Right Hand Level to Sloping Down Side Outlet Tee 321RH 30°-45°  Type 321RH-7 321RH-8	Level to Sloping Down Tee 325 30°-45°  Type 325-7 325-8	Level to Sloping Up Tee 325A 30°-45°  Type 325A-7 325A-8	Level to Sloping Down or Up Cross 326 30°-45°  Type 326-7 326-8
Three Socket Tee 327 11°-30°  Type 327-7 327-8	Two Socket Cross 328 11°-30°  Type 328-7 328-8	Single Socket Tee 329 11°-30°  Type 329-7 329-8	Eaves Fitting 350  Type 350-8	Ridge Fitting 351  Type 351-8
Angle Base Flange 363 11°-30°  Type 363-7 363-8	Three Socket Tee 427 30°-45°  Type 427-7 427-8	High Capacity Base Flange 623  Type 623-8 623-9	Kee Gate SGEUPC2 	

* Normally used in pairs but sold/priced separately

Components for Safety Barrier Solutions

- Cast iron – BS EN 1562 /1563
- Hot dip galvanised – BS EN 1461
- Can be supplied polyester powder coated
- Unlimited number of applications
- Uses standard steel tube sizes – ISO 65 and BS EN 10255

A Adjustable Cross

B 30

C 30°-45°

D Type 30-6
30-7
30-8



A Description
B Fitting
C Angle
D Type: Fitting-Size

Fitting-Size	Tube diameter (mm o.d.)	Nominal bore*1 (mm)
3	17.5	10
4	21.3	15
5	26.9	20
6	33.7	25
7	42.4	32
8	48.3	40
9	60.3	50

*1 Nominal bore is an arbitrary dimension, because the bore varies with the wall thickness of the tubes.



Kee Safety Limited
 Cradley Business Park
 Overend Road
 Cradley Heath
 West Midlands
 B64 7DW
 United Kingdom

Tel: +44 (0) 1384 632 188
Fax: +44 (0) 1384 632 192
Email: sales@keesafety.com
Web: www.keesafety.co.uk



Scan the QR code to visit our website

